

FIASCO CASES ARE OPTIMIZED FOR 96" & 90" TRUCK PACKOLOGY:

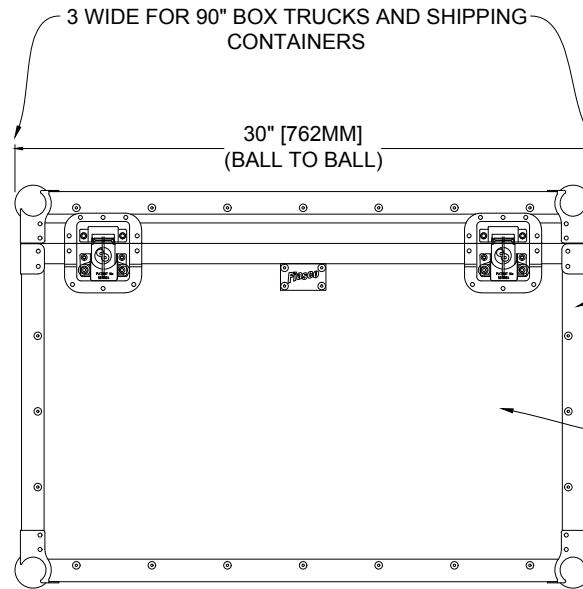
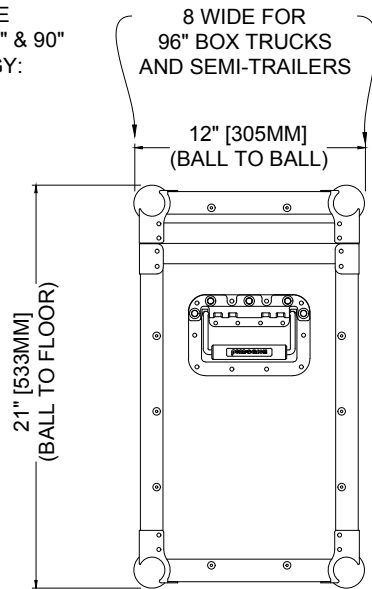

penn-alcom
2MM EXTRUSION & ZINC PLATED HARDWARE

ULTRA LIGHTWEIGHT HONEYCOMB STRUCTURED 3/8" POLYPROPYLENE FLIGHT PANEL
40% LIGHTER THAN PLYWOOD

↑ EXTERNAL VIEW ↑
↓ INTERNAL VIEW ↓

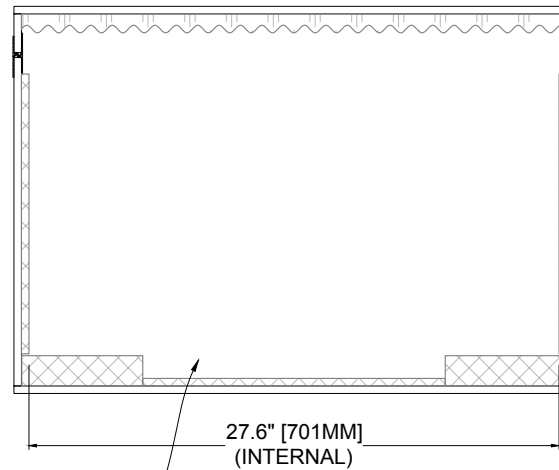
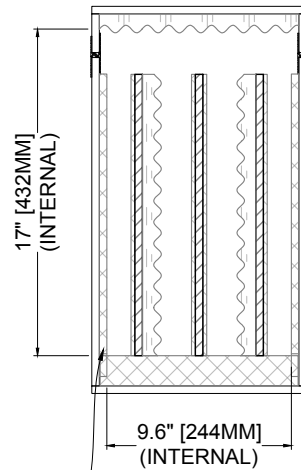

DURABLE HARD FOAM LINING

INTERNAL CAPACITY: 2.6FT³ [74L]
SHIPPING VOLUME: 4FT³ [0.12M³]
WEIGHT: 41LB [18.6KG]

INCLUDING 3 FOAM LINED LONGWAY DIVIDERS,
1 CROSSWAY DIVIDER & 1 FILLER FOAM BLOCK

sales@fiascocases.com // (323) 528-2430

VERSION HISTORY	
NOTES	DATE
ORIGINAL <td>5.00 21-JUN-17 </td>	5.00 21-JUN-17

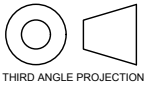

TITLE: **12 X 30 CASE**
SHEET: **OVERVIEW**
FIASCOCASES.COM

DATE: 21-JUN-17
DESIGNED: MARTIN KAUBITZSCH
PROJECT MANAGER: JOE BRADFORD

SCALE	1:10
PAPER	A4
FILE	12 X 30 CASE V5.00.dwg
PLOT	04/11/2019 10:50 AM
SHEET	1 OF 2

VERSION



FIASCO BIRCH PLY INTERLOCK DIVIDERS:

INTERGRATED SLOTS IN THE CASE ALLOW DIVIDERS TO BE RAPIDLY CONFIGURED TO SUIT YOUR APPLICATION.

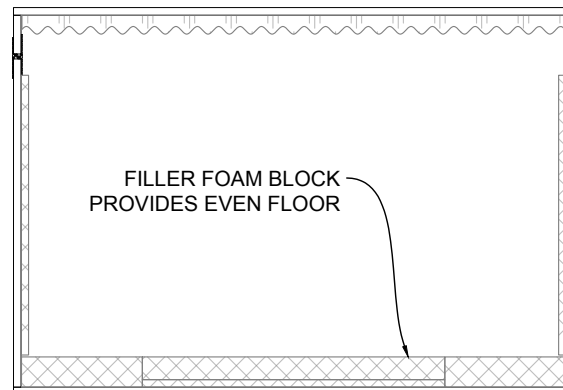

TAKES UP TO TWO 27" MONITORS (ONE RIGHT WAY UP, ONE UPSIDE DOWN)

FOAM LINED DIVIDERS CAN BE POSITIONED EVERY 3/8" TO PROVIDE TIGHT FIT

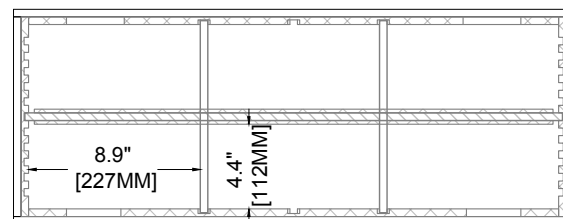
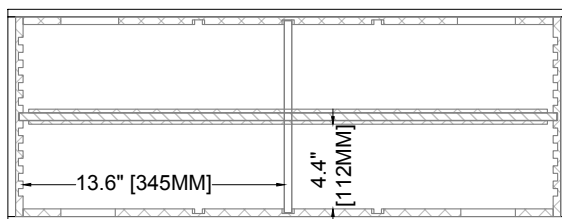
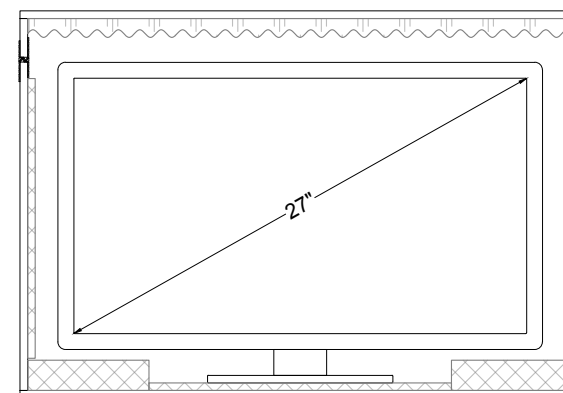
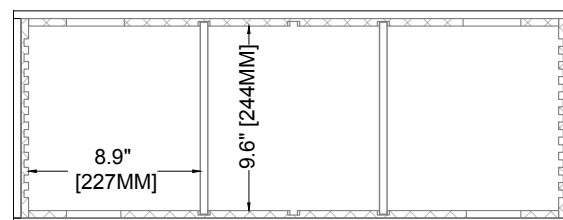
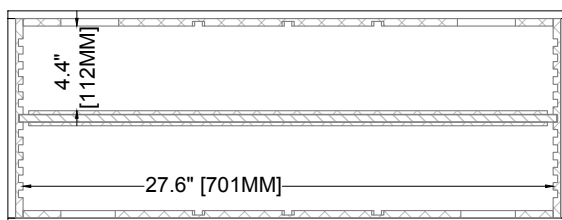
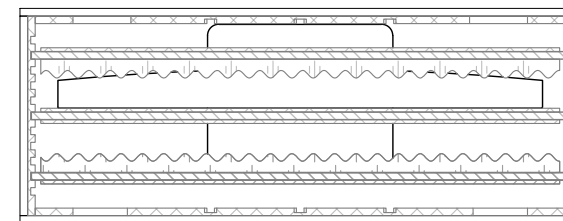
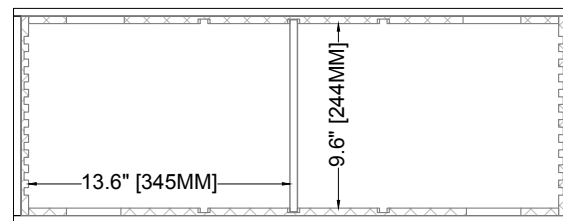
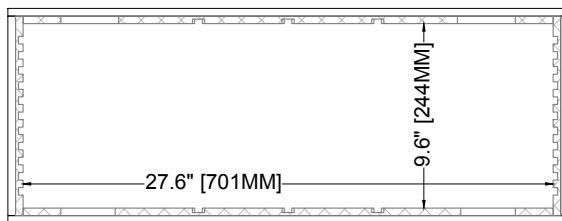

VERSION HISTORY	NOTES
#	DATE
5.00	21-JUN-17
	ORIGINAL



THIRD ANGLE PROJECTION

TITLE
12 X 30 CASE
SHEET
FIASCO INTERLOCK DIVIDERS
FIASCOCASES.COM

DATE
21-JUN-17
DESIGNED
MARTIN KAUBITZSCH
PROJECT MANAGER
JOE BRADFORD

SCALE | 1:10
PAPER | A4
FILE | 12 X 30 CASE V5.00.dwg
PLOT | 04/11/2019 10:51 AM
SHEET | 2 OF 2

VERSION

